

断面図

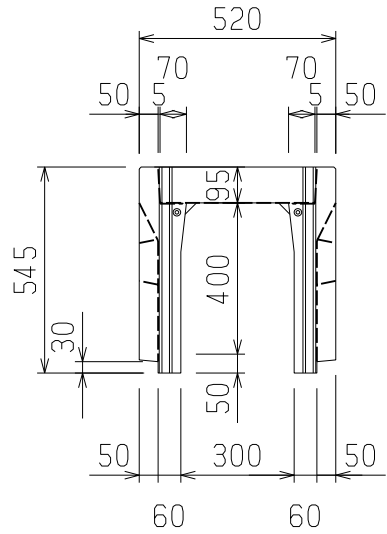

L = 2000

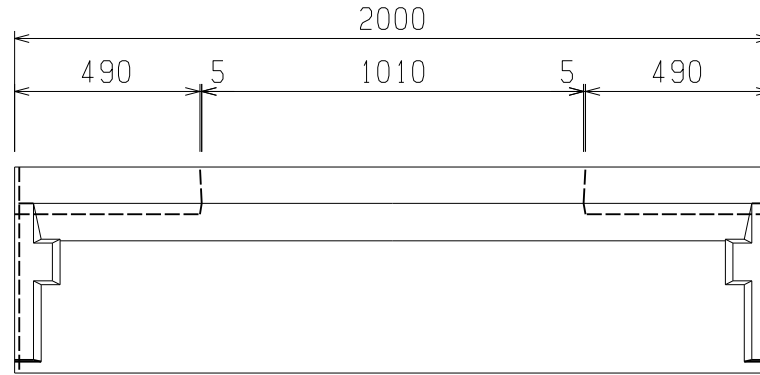

L = 1000

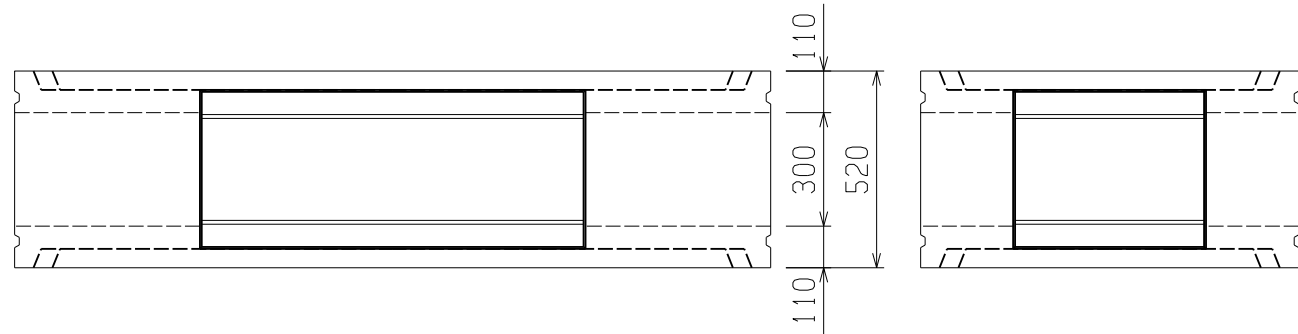
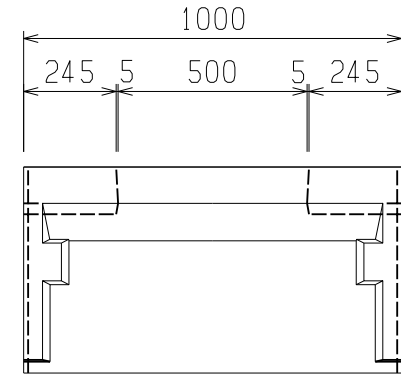

L = 2000 : 458 kg  
L = 1000 : 236 kg

図名	KNS側溝 F 300×400		
尺度	1/20	参考重量	---
小倉セメント製品工業株式会社			