

断面図

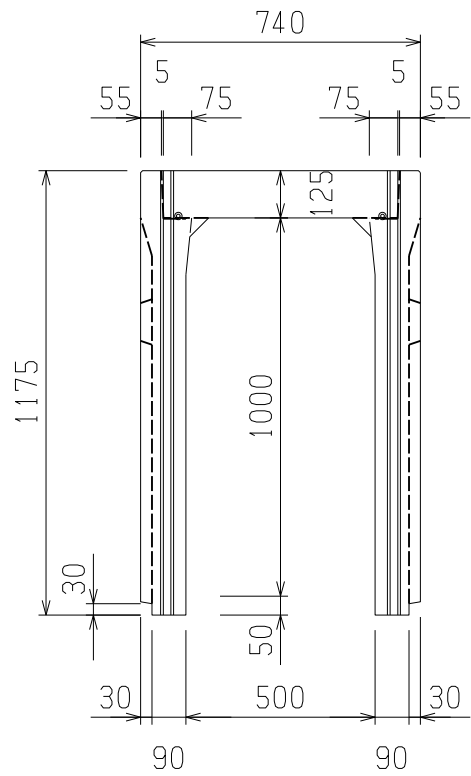

L = 2000

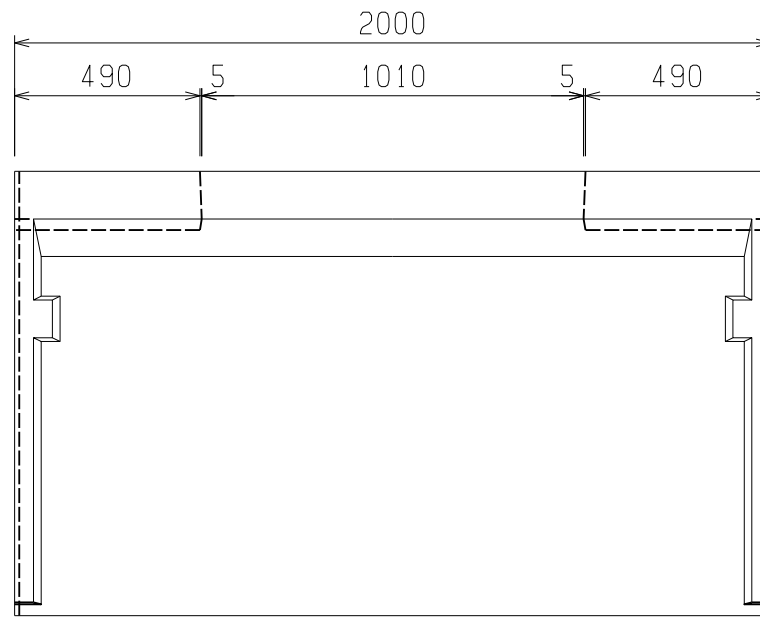

L = 1000

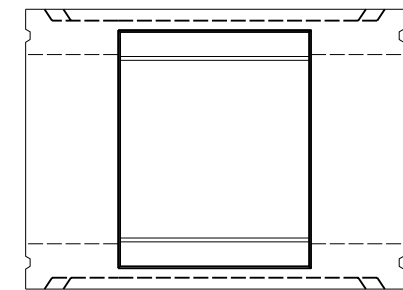
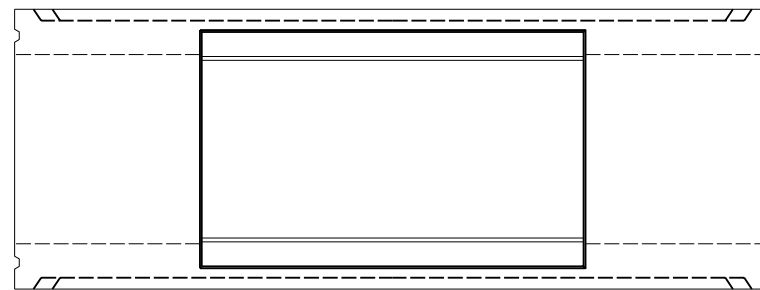
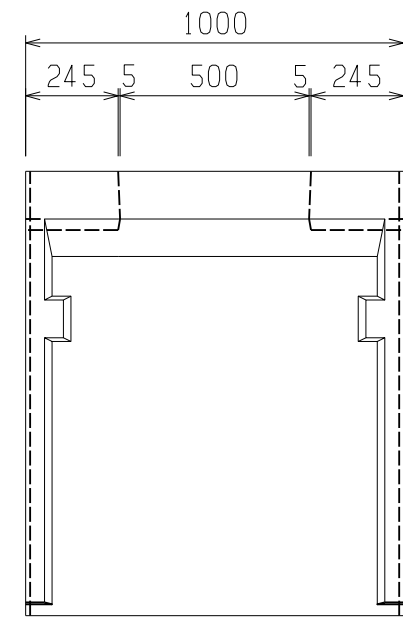

L = 2000 : 1224 kg
L = 1000 : 619 kg

図名	KNS側溝 F 500×1000		
尺度	1/20	参考重量	---
小倉セメント製品工業株式会社			